

SAGOLA ®
an Elcometer company

2023

**HARDWARE
AND DECORATION
PROFESSIONAL EQUIPMENT**

For more than **68 years** we have worked hard to be the best at what we do, so you can be the best at what you do.

Since 1955

SAGOLA can trace its origins to the year 1955 and is fruit of the pioneering spirit of its founder, **Alejandro Sánchez Larrauri**.

It began as a small subcontracting workshop for industry. After some years in the subcontracting sector, Larrauri felt the need to manufacture his own product and progressively withdrew from subcontracted activity.



International expansion

Due once again to the entrepreneurial spirit of the SAGOLA team, the need was felt to open the company to the international market. For that reason the Company began operating in related markets such as Latin America, where it soon became the indisputable leader, later expanding to Arab countries, Asia and finally Europe. Today, SAGOLA is present in more than 80 countries worldwide.

SAGOLA has maintained the highest quality standards in the manufacture of its products from its very beginnings, which has contributed to becoming a very important competitor in sectors such as bodyshop and industry.

Elcometer Group

In 2020, SAGOLA has become part of a much larger business group. The ELCOMETER Group. Headquartered in the UK, Elcometer is also a family business and has been owned by the Sellars family for seven generations. Beginning in the 19th century as a chemical company, Elcometer, headquartered in Manchester, UK, has grown into one of the world's leaders in the design, manufacture and supply of equipment for the coating and non-destructive testing industries (END).

Elcometer exports more than 90% of the products it manufactures through its offices in France, Germany, Japan, the Netherlands, Singapore, the United Arab Emirates and the USA and its global distribution network that covers more than 170 countries throughout the world.

Like Sagola, the philosophy of the Elcometer company is to integrate quality into all aspects of the products they design and manufacture, while being very aware of the environment that surrounds us. Elcometer's commitment is reflected in its ISO 9001 and 14001 Quality and Environmental accreditations.



Our History

1955

SAGOLA foundation as a subcontracting company

1960

SAGOLA begins manufacturing spray guns. Launches the Sagola ALM 401

1966

Expansion of SAGOLA facilities

1973

Due to its growth, SAGOLA builds the new facilities

1980

Sagola is a leader in Spain, Arab countries and Latin America

1990

Sagola launches its low-emission solvent products on the market. One of the top three manufacturers worldwide

1999

Sagola launches the 4200 G spray gun

2007

Sagola launches its first interchangeable HVLP air nozzle

2010

Sagola exports to more than 80 countries

2016

Investment in the latest technology and automation of its manufacturing processes. Sagola launches the 4600 Xtreme spray gun

2020

Sagola is part of the Elcometer Group

2022

Sagola launches the new innovation of the 4100 range spray gun.

Product Index

1

Sprayguns

6

page 6	Classic Pro XD Gravity
page 8	Classic Lux Gravity
page 10	3300 GTO suction
page 12	Classic Pro suction
page 13	Classic Lux suction
page 14	472 Pro
page 16	Junior G
page 17	Sagola 474

2

Painting Kits

18

page 18	Super Kit
page 19	Junior Kit

3

Decoration guns

20

page 20	Premium 429 N
page 21	Classic Pro XD Smooth
page 22	Classic Gotele Pressure
page 23	Premium 419

4

Accessories

24

page 24	Spraygun accessories
page 26	Aircaps / Needle & Nozzle Kits

5

Filtering systems

27

page 27	Plus range filters
page 30	FR/FRL/RA range filters

6

Compressed air

31

page 31	Air hoses
page 32	Couplings and Connectors

7

Airbrushing

36

page 36	XTech range and beginner Airbrush
---------	-----------------------------------

8

General applications

37

page 37	Classic P1 Oil Gun
page 37	Sagola Adhesives gun

9

Complements

38

page 38	3900 Plus sealant guns
page 40	416 anti-gravel gun
page 41	Classic S1 Blowguns
page 42	Turbo 1000 turbine
page 43	Inflator - checker gun

10

Breathing mask

44

page 44	MP 300 breathing mask
page 45	Classic MP2 breathing mask
page 46	FFP2 mask

11

Paint preparation

47

page 47	Consumables
---------	-------------

Worldwide Support

ENGLAND, UK

Elcometer Limited
+44 (0)161 371 6000
sales@elcometer.com
www.elcometer.com



NETHERLANDS

Elcometer B.V.
+31 (0)30 259 1818
nl_info@elcometer.com
www.elcometer.nl

FRANCE

Elcometer Sarl
+33 (0)2 38 86 33 44
fr_info@elcometer.com
www.elcometer.fr

SPAIN

Sagola S.A.U.
+34 945 214 150
sagola@sagola.com
www.sagola.com



GERMANY

Elcometer Instruments GmbH
AALEN: +49 (0) 7361 52806 0
LEER: +49 (0) 7361 528 06 60
de_info@elcometer.com
www.elcometer.de

UNITED ARAB EMIRATES

EL Inspection & Blasting Equipment LLC
+971 4 295 0191
+971 4 280 3526
uae_sales@elcometer.com
www.elcometer.ae

After the incorporation of Sagola to the Elcometer group, its international network of own offices has been increased in a very significant way. Due to this new international network of offices worldwide, the acquisition of all the products manufactured by Sagola for the different business sectors is now much easier. However, Sagola has distributors in more than 80 countries.

JAPAN

Elcometer KK
+81 (0)3 6869 0770
jp_info@elcometer.com
www.elcometer.co.jp

UNITED STATES OF AMERICA

Elcometer Inc
WARREN, MI: +1 248 650 0500
HOUSTON, TX: +1 713 450 0631
Toll Free: 800 521 0635
inc@elcometer.com
www.elcometer.com



MEXICAN REPUBLIC

Sauritech SA de CV
+52 442 388 5099
ventas@sagolamexico.com.mx
www.sagolamexico.com.mx



REPUBLIC OF SINGAPORE

Elcometer (Asia) Pte Ltd
+65 6462 2822
asia@elcometer.com
www.elcometer.com



We are here to help...

sagola@sagola.com
www.sagola.com

Sagola Classic Pro XD gravity



The Sagola Classic Pro XD Primer Gun incorporates EPA and HVLP high transfer air caps.

“Metal to metal” technology. No joints or plastic parts in the product area.

Nozzle and needle made of stainless steel.

Matt chrome-plated injected aluminum body.

Maximum ergonomics and comfort.

High transfer in finishes and primers

TECHNICAL DATA

CLASSIC PRO XD

Weight with cup	665 grams	1.47 lbs
Weight without cup	480.8 grams	1.06 lbs
Dimensions with cup	17.9 x 17.7 cm.	7.05 x 6.96 "
Width of handle	1.9 cm.	0,75 "
Air inlet connection	BSP 1/4" Male	
Cup	650 ml. (22 fl oz.) capacity Cup with anti-drip system	
Recommended working pressure	2 bar	29 psi
Materials in contact with the product	Anodized aluminum, chromed aluminum, POM, Stainless steel and Teflon	

Sagola Classic Pro XD gravity

Classic Pro XD aircaps technical data / Versions



21 EPA Aircap. Sagola EPA high transfer technology that combines high transfer rates with high atomization capacity. Low air consumption.

Recommended application	Recommended nozzle	Product output flow	Fan size	Application distance	Code Classic Pro XD
FINISHES	1.40	143 g/min. (5.04 oz/min.)	285 mm. (11.2")		10141620
FINISHES AND PRIMERS	1.60	147 g/min. (5.19 oz/min.)	290 mm. (11.4")	18 - 20 cm. (7 - 7.9")	10141623
FONDS AND PRIMERS	1.80	179 g/min. (6.31 oz/min.)	320 mm. (12.6")		10141625

Air consumption at 2 bar (29 psi):
225 L/min. (7.95 cfm)

Recommended pressure:
1.5 - 2.0 bar (21.7 - 29 psi)



HVLP Aircap. Compliance with the strictest environmental regulations. High Transfer HVLP Technology. High application speed.

Recommended application	Recommended nozzle	Product output flow	Fan size	Application distance	Code Classic Pro XD
FINISHES	1.40	143 g/min. (5.04 oz/min.)	285 mm. (11.2")		10141621
FINISHES AND PRIMERS	1.60	202 g/min. (7.13 oz/min.)	250 mm. (9.8")	12 - 15 cm. (4.7 - 5.9")	10141624
PRIMERS HIGH THICKNESS	1.80	235 g/min. (8.29 oz/min.)	280 mm. (11.2")		10141626
PRIMERS HIGH VISCOSITY	2.50	270 g/min. (9.52 oz/min.)	325 mm. (12.8")		20140831

Air consumption at 2 bar (29 psi):
355 L/min. (11.54 cfm)

Recommended pressure:
1.5 - 2.0 bar (21.7 - 29 psi)



25 & 36 Aircaps. Specially designed for the application of high thickness fillers.
28 Aircap. The best option for the application of gun fillers on large surfaces.
High product flow rates for thick products.

Recommended application	Nozzle	Aircap	Product output flow	Fan size	Application distance	Code Classic Pro XD
PRIMERS HIGH THICKNESS	2.00	25	218 g/min. (7.69 oz/min.)	250 mm. (9.8")		10141627
PRIMERS HIGH VISCOSITY	2.50	36	249 g/min. (8.78 oz/min.)	280 mm. (11.2")	18 - 20 cm. (7 - 7.9")	10141629
GUN FILLER	2.80	28	263 g/min. (9.29 oz/min.)	250 mm. (9.8")		10141630

Air consumption at 2 bar (29 psi):
25 Aircap: 155 L/min. (5.47 cfm)
36 Aircap: 205 L/min. (7.24 cfm)
28 Aircap: 240 L/min. (8.48 cfm)

Recommended pressure:
1.8 - 2.5 bar (26.10 - 36.26 psi)



Catalogue 2023

**Hardware
and Decoration**

Sprayguns

Classic Lux Gravity



Ergonomic

Lightweight and comfortable

Versatile

Variety of applications

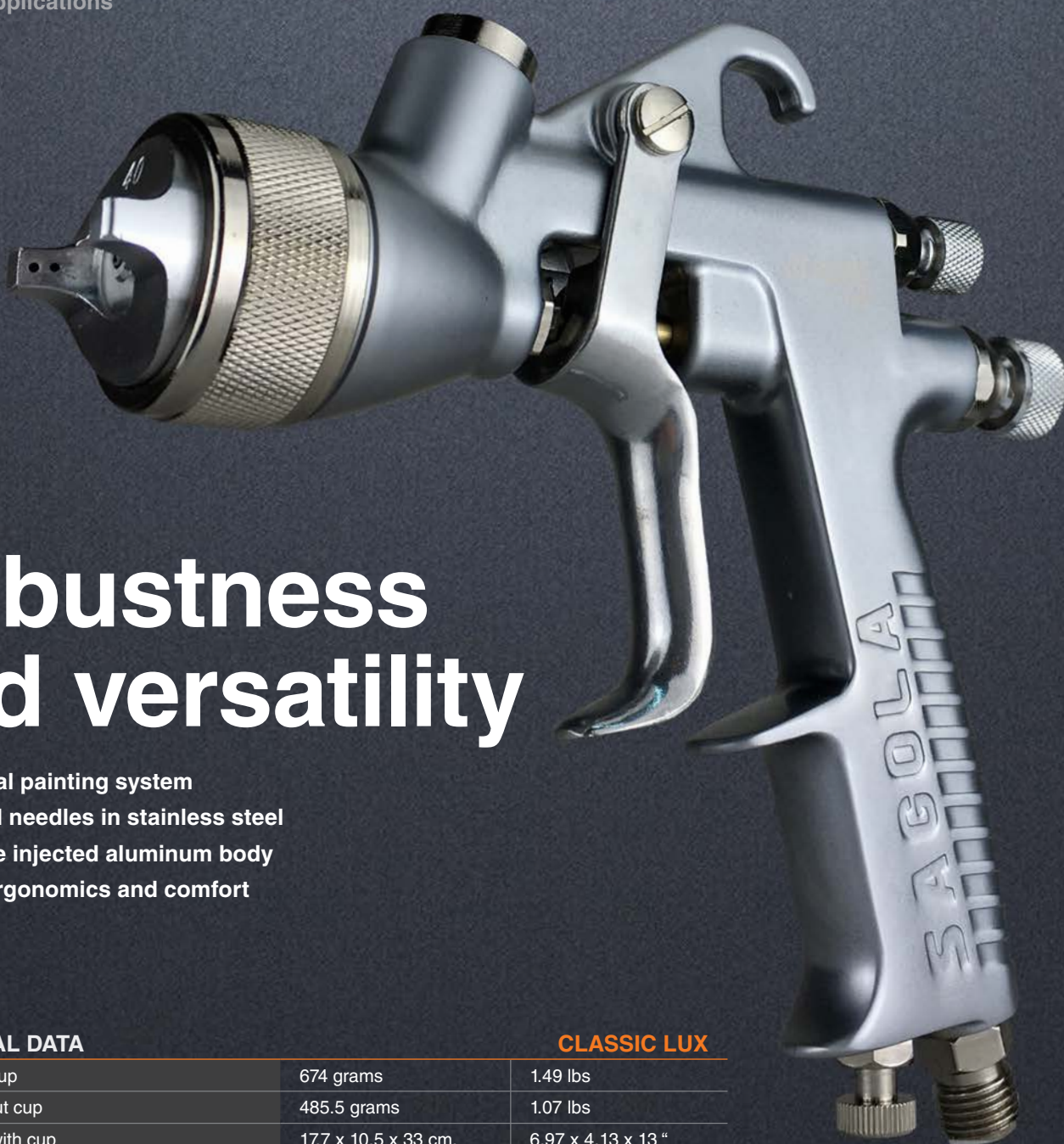

Robustness and versatility

Conventional painting system

Nozzles and needles in stainless steel

Matt chrome injected aluminum body

Maximum ergonomics and comfort

TECHNICAL DATA

CLASSIC LUX

Weight with cup	674 grams	1.49 lbs
Weight without cup	485.5 grams	1.07 lbs
Dimensions with cup	17.7 x 10.5 x 33 cm.	6.97 x 4.13 x 13 "
Dimensions without cup	17.7 x 1.9 x 17.1 cm.	6.97 x 0.75 x 6.73 "
Air inlet connection	BSP 1/4" Male	
Cup	650 ml. (22 fl oz.) capacity Cup with anti-drip system	
Recommended working pressure	2 bar	29 psi
Materials in contact with the product	Anodized aluminum, chromed aluminum, POM, Stainless steel and Teflon	

Classic Lux Gravity

The SAGOLA Classic LUX gun offers one of the best quality/price ratios in its range of conventional primer guns.

With a new body design and improved ergonomics, the Classic LUX spraygun expands the range of responses and application solutions.

Single shaft design. Less number of parts, minimum maintenance. No joints between the air and the paint. One piece packing gland. Internal air distributor.

Nozzles and needles in stainless steel. Air, product and fan flow regulators.



40 AIRCAP
Primers and fillers
Available nozzles:
1.40 / 1.60 / 1.80



41 AIRCAP
Primers and fillers
High thickness
Available nozzles: 2.00



42 AIRCAP
Fillers
High viscosity. Gun fillers.
Available nozzles: 2.50

Cup

650 ml. cup capacity. Includes anti-drip system and paint filter.

Low air consumption

High quality of aircaps, with low air consumption.

Body

Novelty in the chrome of the gun body. Matte chrome.

Nozzle and Needle

Made of stainless steel.

Classic Lux aircaps technical data / Versions

Recommended application	Nozzle	Aircap	Product output flow	Fan size	Application distance
FINISHES	1.40	40	218 g/min. (7.7 oz/min.)	210 mm. (8.26")	
PRIMERS AND FILLERS	1.60	40	125 g/min. (4.4 oz/min.)	215 mm. (8.46")	18 - 20 cm. (7 - 7.9")
FILLERS	1.80	40	217 g/min. (7.6 oz/min.)	250 mm. (9.84")	
FILLERS HIGH THICKNESS	2.00	41	206 g/min. (7.3 oz/min.)	255 mm. (10.04")	18 - 20 cm. (7 - 7.9")
PUTTIES	2.50	42	144 g/min. (5.1 oz/min.)	215 mm. (8.46")	

Code Classic Lux
20141406
20141401
20141402
20141404
20141403



Air consumption at 2 bar (29 psi):
40 Aircap: 190 L/min. (6.71 cfm)
41 Aircap: 210 L/min. (7.42 cfm)
42 Aircap: 220 L/min. (7.77 cfm)

Recommended pressure:
1.5 - 2.5 bar (21.7 - 36.26 psi)

Accessories

Code	Description
56418420	Gravity cup 650 ml. (6.76 fl oz) - includes product filter
56418017	Gravity cup product filter 650 ml. (10 units)
40000335	RC2 Air flow regulator with pressure gauge



RC2 Air flow regulator with pressure gauge
(See page 68)

Sagola 3300 GTO suction

Ideal for painting large surfaces, machinery and industrial vehicles

Continuous working days



Versatility. Industrial finishes

With the 3300 GTO suction spraygun, SAGOLA offers a very high level product with an excellent quality / price ratio. This suction spraygun is characterized by its versatility.

High performance spraygun. High speed application for painting large surfaces. Offers large fan sizes.

Ideal for the application of enamels, varnishes, primers and basecoats.

High-end aluminum aircaps. Nozzles and needles made of stainless steel.

TECHNICAL DATA

3300 GTO SUCTION

Weight with deposit	869 grams	1.92 lbs
Weight without deposit	474 grams	1.04 lbs
Dimensions with deposit	18.7 x 10.6 x 28.7 cm.	7.36 x 4.17 x 11.31 "
Dimensions without deposit	17.8 x 17.5 cm.	7.01 x 6.91 "
Width of handle	1.9 cm.	0.75 "
Air inlet connection	BSP 1/4" Male	
Deposit	1,000 ml. capacity (34 fl oz.) Cup with anti-drip system	
Product filter	Nylon mesh	
Recommended working pressure	2 - 3 bar (29 - 43.5 psi)	
Average sound pressure level	80 dB	
Materials in contact with the product	Anodized aluminum, chromed aluminum, POM, Stainless steel, Teflon and Nylon	

Sagola 3300 GTO suction

Spraygun main news

01 SUPER LIGHT. -METAL TO METAL- TECHNOLOGY.

No sealing joints between components.

02 High strength FORGED ALUMINUM BODY.
REGISTER DC 924667-0004 DESIGN REGISTER.

03 ALUMINUM AIRCAPS.

3300 EPA. Ultra-fine atomization and larger fans. Designed for the best response at any pressure. With mechanized aerodynamic caps which eliminate turbulence and reverse painting.

04 One single piece AUTOMATIC PAINT PACKING GLAND.

Unique in the market. It avoids manipulation and breakage of the glands and makes it easier to remove for the thorough cleaning of the paint area.

05 ERGONOMIC TRIGGER. Made of stainless steel. It reduces fatigue.

06 NOZZLE AND NEEDLE. Made of stainless steel.

07 SINGLE SHAFT SYSTEM.

Directly continuing Xtreme model series with a simplified design, synchronized performance in any kind of situation, fewer parts, and maintenance reduction.

08 HIGH PRECISION AIR INLET REGULATOR. Modern design without sharp edges, it makes easier cleaning. Higher control precision. Ideal for quick adjustment.

09 AIR FLOW REGULATOR with PRESSURE GAUGE.

It maintains the working pressure according to the parameters of Emissions regulations. (Green scale). Code 40000335

10 1L SUCTION DEPOSIT.

made of aluminum. Maximum use of the product. Watertight system with double closure and anti-drip lid.

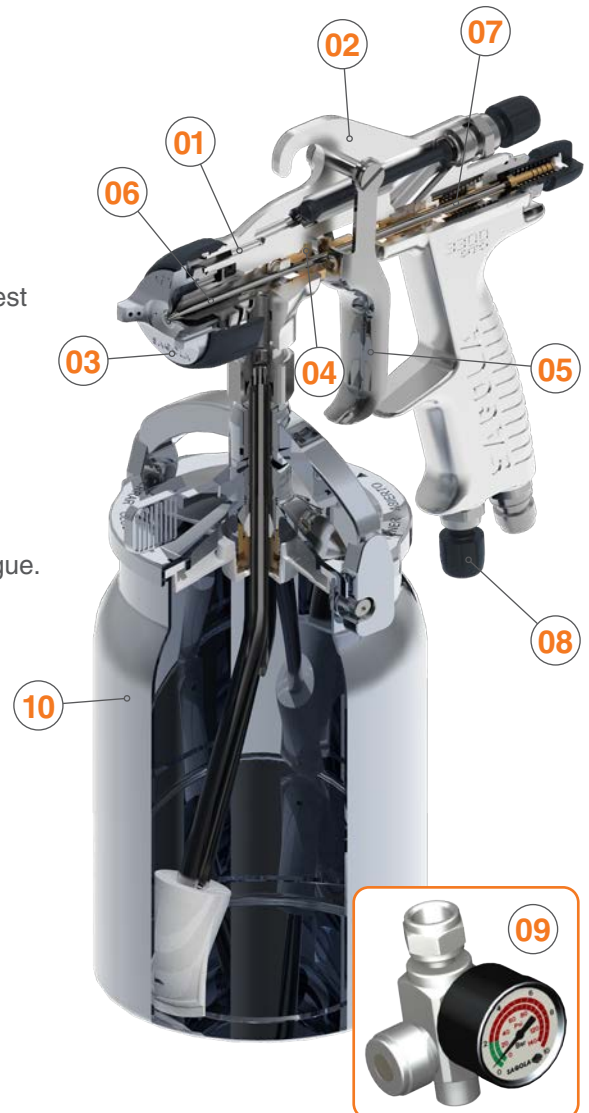

3300 GTO aircaps technical data / Versions



3300 EPA Aircap. Versatility and perfect adaptation to any type of industrial painting project. High gloss finishes, primers and high viscosity paints. Its sustained air consumption, together with the high percentages of product transfer, make SAGOLA's EPA aircaps the most balanced system on the market.



Recommended application	Recommended nozzle	Aircap	Product output flow	EPA PAINTED SYSTEM		Code Spraygun
				Fan size	Application distance	
HIGH QUALITY FINISHES	1.40	3300 EPA	179 g/min. (6.3 oz/min.)	245 mm. (9.6")		10120910
GENERAL FINISHES	1.60	3300 EPA	156 g/min. (5.5 oz/min.)	225 mm. (8.9")	18 - 20 cm. (7 - 7.9")	10120911
FINISHES AND PRIMERS	1.80	3300 EPA	184 g/min. (6.5 oz/min.)	245 mm. (9.6")		10120912

Air consumption at 2 bar (29 psi): 250 L/min. (8.8 cfm)

Recommended pressure:
2.0 - 2.5 bar (29 - 36 psi)

Sagola Classic PRO suction

Classic PRO suction, Sagola's suction gun with the best quality/price ratio in conventional or medium pressure painting.

Robust and extremely reliable gun. Injected aluminum body.

Aluminum regulators and high transfer nozzles with a spray of the highest quality.

Single shaft system design for fewer maintenance parts. There are no O-rings. Nozzles and needles made of stainless steel. One-piece packing gland.

Large deposit capacity, with double watertight paint closure system and flange closure with gasket and anti-drip lid. The sprung weight reduces fatigue compared to higher deposits.



21 EPA Aircap. High transfer Sagola EPA technology that combines high transfer rates with a high atomization capacity. Low air consumption.

EPA PAINTED SYSTEM

Recommended application	Recommended nozzle	Product output flow	Fan size	Application distance
FINISHES	1.60	147 g/min. (5.19 oz/min.)	290 mm. (11.4")	18 - 20 cm. (7 - 7.9")
PRIMERS AND FONDS	1.80	179 g/min. (6.31 oz/min.)	320 mm. (12.6")	

Air consumption at 2 bar (29 psi): 225 L/min.
(7.95 cfm)

Recommended pressure:
2.0 - 2.5 bar (29 - 36 psi)

Code
Spraygun

10120701

10120702



TECHNICAL DATA

Weight with deposit	928 grams	2 lbs
Dimensions with deposit	17.5 X 11 X 29 cm.	6.9 x 4.3 x 11.4 "
Air inlet connection	BSP 1/4" Male	
Deposit	1,000 ml. capacity (34 fl oz.) Cup with anti-drip system	
Recommended working pressure	2 - 3 bar (29 - 43.5 psi)	
Materials in contact with the product	Anodized aluminum, chromed aluminum, POM, Stainless steel, Teflon and Nylon	

CLASSIC PRO SUCTION

Sagola Classic LUX suction

Classic LUX suction, gun with conventional painting system from Sagola's economic range.

Robust and highly versatile pistol. Ideal for a wide variety of applications.

Injected aluminum body, matt chromed. High ergonomics and comfort for the painter.

High quality of aircaps with very low air consumption.

Needles and nozzles are made of stainless steel.

Includes product, air and fan regulators.

High capacity product tank (1 liter). Maximum use of the product. Double sealing watertight system and anti-drip lid. Includes paint filter.



38 Aircap. Medium pressure Sagola system. Low air consumption. High atomization.

39 Aircap. Medium pressure Sagola system. Low air consumption. High speed application. Grate fan size.

MEDIUM PRESSURE SYSTEM

Recommended application	Recommended nozzle	Aircap	Product output flow	Fan size	Application distance	Code Spraygun
FINISHES	1.60	38	147 g/min. (5.19 oz/min.)	290 mm. (11.4")	18 - 20 cm. (7 - 7.9")	20121101
PRIMERS AND FONDS	1.80	39	179 g/min. (6.31 oz/min.)	320 mm. (12.6")		20121102



Air consumption at 2 bar (29 psi): 225 L/min. (7.95 cfm)

Recommended pressure: 2.0 - 2.5 bar (29 - 36 psi)

TECHNICAL DATA

CLASSIC LUX SUCTION

Weight with deposit	870 grams	2 lbs
Dimensions with deposit	17.5 X 11 X 29 cm.	6.9 x 4.3 x 11.4 "
Air inlet connection	BSP 1/4" Male	
Deposit	1,000 ml. capacity (34 fl oz.) Cup with anti-drip system	
Recommended working pressure	2 - 3 bar (29 - 43.5 psi)	
Materials in contact with the product	Anodized aluminum, chromed aluminum, POM, Stainless steel, Teflon and Nylon	

Sagola 472 PRO

Optimum ergonomics

Minimum mist

Low air consumption

Multi-use applications

Multi-use spray gun

Pressurized gun with internal mixing nozzle that allows working with very low consumption -only 65 L/min- and very low pressure (1-2 bar).



TECHNICAL DATA

472 PRO

Weight 472 PRO	465 grams	1.49 lbs
Weight PREMIUM 777	780 grams	1.07 lbs
Dimensions 472 PRO	17.7 x 10.5 x 33 cm.	6.97 x 4.13 x 13 "
Dimensions PREMIUM 777	17.7 x 1.9 x 17.1 cm.	6.97 x 0.75 x 6.73 "
Air inlet connection	BSP 1/4" Male	
Deposit	600 ml. capacity (20.3 fl oz.)	
Recommended working pressure	1 - 2 bar	14.5 - 29 psi
Maximum air pressure	3.5 bar	50.8 psi
Materials in contact with the product	Anodized aluminum, chromed aluminum, POM, INOX and Teflon	

Sagola 472 PRO

There are many other guns that look like or are even true replicas of our 472 PRO Gun, but they are not a SAGOLA.

SAGOLA guarantees the best quality of painting.

SAGOLA guarantees the best quality of its components.

SAGOLA guarantees the best supply of spare parts.

SAGOLA offers you a 3-year guarantee.

This is what a SAGOLA gun offers.

The 472 PRO gun is designed for multi-use applications, always achieving the best quality finish even with highly viscous products.

Internal mix spray system on its two air nozzles. Nozzles with perfect uniformity and fan quality: flat jet and round jet. Ideal for 1 component products.

Easy to use and total portability.



**Flat
JET**



**Round
JET**

Deposit

The capacity of the deposit is 600 ml. Optimized paint zone deposit machining

Low air consumption

The lowest air consumption on the market. 65 L/min.

Air caps

Two types of air caps with a perfect uniformity and quality of fan. Flat fjet and round jet.

VERSIONS / ACCESSORIES

Description		Code
Sagola 472 PRO gun		10130102
Sagola 472 PRO gun + PREMIUM 777 Compressor (220V - 50Hz)		10610102
Sagola 472 PRO gun + PREMIUM 777 Compressor (110V - 60Hz)		10610106
Closing joint of the product tank (5 units)	Spare part	50810229
Product packing gland	Spare part	57212214

PREMIUM 777 Compressor



SAGOLA recommends a series of products that together with your 472 PRO Gun will offer you a multitude of applications. That is why the recommendation of the PREMIUM 777

compressor is that, due to its lightness and size, this equipment will allow you to work anywhere without the need to transport large compressors.



PATENTS:

Community Design: D-C 924667-0001
Design in Asia: 200830139663.7

Economic, ergonomic

The SAGOLA Junior G spraygun is a very economical gravity spray gun in contrast to its features.

Spraygun with a robust body. Lightweight and ergonomic exclusive design by Sagola.

Spraygun suitable for working with 1.5 HP power compressors. Very low air consumption.

Incorporates air, product and fan flow regulators. 600 ml. cup capacity. Quick connector included.

Two packaging formats, in box or blister.



BSPP 1/4" quick connector included



TECHNICAL DATA

JUNIOR G

Weight with cup	493 grams	1.09 lbs
Weight without cup	371 grams	0.82 lbs
Dimensions with cup	17 x 10 x 32 cm.	6.7 x 3.9 x 12.6 "
Dimensions without cup	14.5 x 5.4 x 17 cm.	5.7 x 2.1 x 6.7 "
Air inlet connection	BSP 1/4" Male	
Cup	600 ml. (20.3 fl oz.) capacity Cup with anti-drip system	
Recommended working pressure	2 bar	29 psi
Materials in contact with the product	Anodized aluminum, chromed aluminum, POM, Stainless steel and Brass	

Technical data / Versions

Recommended application	Version	Product output flow	Fan size	Application distance
FINISHES	1.40	189 g/min. (6.67 oz/min.)	230 mm. (9.06")	
FINISHES AND PRIMERS	1.60	194 g/min. (6.84 oz/min.)	255 mm. (10.04")	18 - 20 cm. (7 - 7.9")
FILLERS AND PRIMERS	1.80	221 g/min. (7.80 oz/min.)	265 mm. (10.43")	

Code Junior G	Code Junior G
20141904	-
20141903	-
20141902	20141905

Air consumption at 2 bar (29 psi):
 1.40/1.60: 125 L/min. (4.4 cfm)
 1.80: 115 L/min. (4 cfm)

Recommended pressure:
 2.0 bar (29 psi)

Custom box

Blister

Sagola 474



Mini airbrush gun

Small-sized gravity spraygun special for retouches. Economic spraygun.

Ideal for painting small areas and marking parts.

Incorporates air, product and fan flow regulators. 120 ml. gravity cup capacity.

It is presented in a customized box and in two versions of nozzles, 0.80 and 1.00 for sale.

TECHNICAL DATA

SAGOLA 474

Weight with cup	325 grams	0.72 lbs
Weight without cup	273 grams	0.60 lbs
Dimensions with cup	11.5 x 6.5 x 24 cm.	4.53 x 2.56 x 9.45 "
Dimensions without cup	10.5 x 3.2 x 15.5 cm.	4.13 x 1.26 x 6.10 "
Air inlet connection	BSP 1/4" Male	
Cup	120 ml. (4.06 fl. oz.) capacity Cup with anti-drip system	
Recommended working pressure	2 bar	29 psi
Materials in contact with the product	Anodized aluminum, chromed aluminum, POM, Stainless steel and Teflon	



Technical data / Versions

Recommended application	Version	Product output flow	Fan size	Application distance
FINE FEATHERING	0.80	37 g/min. (1.31 oz/min.)	135 mm. (5.31")	18 - 20 cm. (7 - 7.9")
SMALL AREAS AND PARTS MARKING	1.00	58 g/min. (2.05 oz/min.)	155 mm. (6.10")	

**Code
Sagola 474**

10151701

10151702

Custom box

Air consumption at 2 bar (29 psi):
0.80: 75 L/min. (2.65 cfm)
1.00: 70 L/min. (2.47 cfm)

Recommended pressure:
2.0 bar (29 psi)



Complete painting kit

Complete professional painting kit. Ideal for painting hardware, metal and decoration.

The kit includes a CLASSIC LUX gravity paint gun, version 1.80, nozzle 40. Light and versatile gun, highly reliable.

Inflator - pressure tester CLASSIC I, of high resistance and precision.

Liquid sprayer, CLASSIC P1 oil pump with a 1 L tank capacity. Made of aluminum and with a metal nozzle. Adjustable flow.

CLASSIC S1 blow gun with metal nozzle and body made of aluminum.

TECHNICAL DATA

SUPER KIT

Weight with packaging	2,762 grams	6.1 lbs
Packing dimensions	52 x 35.5 x 13.5 cm.	20.5 x 14 x 5.3 "

VERSIONS

Description	Code
Professional painting kit SUPER KIT	20160103





DIY painting kit

Complete professional painting kit. Ideal for DIY painting.

DIY kit of 5 tools for painting.

A quick connector is attached to all tools.

The kit includes a Junior G gravity spray gun, with very low air consumption and a high transfer air cap.

Inflator and pressure checker. Impact gauge protector. Pressure reading in Bar/Psi.

Liquid sprayer.

Air hose with terminals and connectors.

TECHNICAL DATA

		JUNIOR KIT
Weight with packaging	1,868 grams	4.1 lbs
Packing dimensions	42 x 21.5 x 12 cm.	16.5 x 8.5 x 5 "

VERSIONS

Description	Code
DIY painting kit JUNIOR KIT	20160105



Gotele and textured finishes

Special gun for construction and decoration work such as stone, gotelé, projected cork, viscous products in general. It contains a high-quality, 5-liter capacity tank with a handle and a removable lid for easy cleaning.

It incorporates product and air flow regulators.

Non-stick coating on the body of the gun for easy cleaning.

Trigger lock system to facilitate continued use.

Includes a product anti-blocking system. With shut-off valve for air inlet and 4.5, 6 and 8 mm nozzles.



Gotele



Stone Products



Japanese paste

TECHNICAL DATA

PREMIUM 429 N

Weight with deposit	1,230 grams	2.7 lbs
Weight without deposit	840 grams	1.85 lbs
Packaging dimensions	26.3 x 26.3 x 27 cm.	10.3 x 10.3 x 10.6 "
Dimensions without tank	20 x 23 cm.	7,9 x 9 "
Air inlet connection	BSP 1/4" Male	
Deposit	5,000 ml capacity. (169 fl oz.) With removable lid and handle	
Recommended working pressure	2 bar	29 psi
Materials in contact with the product	Anodized aluminum, chromed aluminum, POM, INOX and Brass	



Air caps Kit
4.5, 6 and 8 mm.

VERSIONS / ACCESSORIES

Description		Code
Sagola PREMIUN 429 N gun		10140201
Air cap + needle special for Gotele 3 mm.	Accessory	56418065
Air cap + needle special for Japanese paste	Accessory	56418066
Air cap + needle special for Liquid stone and projected cork	Accessory	56418067
5 liter tank with handle (removable) <i>Included</i>	Accessory	56418078
5 liter tank with handle	Accessory	56418077
4.5, 6 y 8 mm. nozzle kit	Spare Part	56418418



5 liter tank

Classic XD Smooth

Plastic paints and high viscosity

Special gun for decoration work with highly viscous products such as plastic and multicolored paints.

It contains a high-quality, 5-liter capacity tank with a handle and a removable lid for easy cleaning.

It incorporates product, fan and air flow regulators.

Non-stick coating on the body of the gun for easy cleaning.

High ergonomics to reduce fatigue from continued use.



TECHNICAL DATA

CLASSIC PRO XD SMOOTH

Weight with deposit	1,100 grams	2.43 lbs
Weight without deposit	480.8 grams	1.06 lbs
Packaging dimensions	26.3 x 26.3 x 27 cm.	10.3 x 10.3 x 10.6 "
Dimensions without tank	17.7 x 17.9 cm.	5.7 x 2.1 x 6.7 "
Handle Width	1.9 cm.	5.7 x 2.1 x 6.7 "
Air inlet connection	BSP 1/4" Male	
Deposit	5,000 ml capacity. (169 fl oz.) With removable lid and handle	
Recommended working pressure	2 bar	29 psi
Materials in contact with the product	Anodized aluminum, chromed aluminum, POM, INOX and Brass	



Special kit
for painted ceilings



Adapter
for 5 liter tank

VERSIONS / ACCESSORIES

Description		Code
Sagola Classic PRO XD Smooth 2.00 [25]		10141640
Sagola Classic PRO XD Smooth 2.50 [36]		10141641
Special kit for painted ceilings	Accessory	56418068
Adapter for 5 liter tank	Spare Part	55711511

High viscosities

Classic Gotele Pressure

Injected aluminum body with external non-stick teflon coating for easy cleaning.

Fluid nozzle and needle made of stainless steel. Valid for water-based products.

It incorporates product and air flow regulators.

High precision in the regulation of the drop.

Low air consumption.

It is recommended to use it together with the pressure boilers of the Sagola Range: Classic 30 Inox and Premium 30.



Gotele



Stone Products



Japanese paste

TECHNICAL DATA

CLASSIC GOTELE PRESSURE

Weight	580 grams	1.28 lbs
Dimensions	16.1 x 4.7 x 19.6 cm.	6.3 x 1.9 x 7.7 "
Air inlet connection	BSP 1/4" Male	
Product inlet connection	BSP 3/4" Male	
Air consumption at 3.5 bar (50.8 psi)	200 L/min.	7.06 cfm
Deposit	Product inlet through pressure pot or pneumatic pump	
Recommended working pressure	2 bar	29 psi
Materials in contact with the product	Injected aluminium, PLM, INOX and Teflon	



Air flow regulator



Raccord
 3/4" F - Barb 19 mm.

VERSIONS / ACCESSORIES

Description	Nozzle	Air cap	Code
Sagola Classic Gotele Pressure	2.80	2.8B	20150901
Sagola Classic Gotele Pressure	3.20	3.2B	20150902
Air flow regulator (Included)	Accessory		56418417
Raccord 3/4" F - Barb 19 mm.	Accessory		56414910

Premium 419

Special gotele Low pressure

Premium 419

Special gun for decoration work with stone, gotele and viscous products.

It incorporates product and air flow regulators.

Non-stick coating on the body of the gun for easy cleaning.

Trigger lock system to facilitate continued use.

Includes a product anti-jam system. With shut-off valve for air inlet.

4.5, 6 and 8 mm. nozzles.



Gotele



Stone Products



Japanese paste

REGULATIONS:

Directive 2014/34/EU
ATEX II 2G x

TECHNICAL DATA

PREMIUM 419

Weight	439 grams	0.97 lbs
Dimensions	17 x 10 x 32 cm.	6.7 x 3.9 x 12.6 "
Product inlet connection	BSP 3/4" Male	
Air inlet connection	BSP 1/4" Male	
Deposit	Product inlet through pressure pot or pneumatic pump	
Recommended working pressure	2 bar	29 psi
Materials in contact with the product	Anodized aluminum, chromed aluminum, POM, INOX and Brass	



Air caps Kit
4.5, 6 and 8 mm.

VERSIONS / ACCESSORIES

Description	Code
Sagola PREMIUM 419 gun	20151001
Air cap + needle special for Gotele 3 mm.	Accessory 56418065
Air cap + needle special for Japanese paste	Accessory 56418066
Air cap + needle special for Liquid stone	Accessory 56418067
4.5, 6 y 8 mm. nozzle kit	Spare Part 56418418

Spraygun Accessories



Air Flow regulator with pressure gauge RC2

Pressure gauge flow regulator. Exact input pressure gun. High quality gauge green scale for high transfer guns.

Code
40000335



Pressurizer kit

for gravity spray guns. Gravity cup pressure kit for high viscosity materials spraying. Non-return valve included.

Code
56418513



Magnetic supports SP2 and SP1

Magnetic mounts for 1 (SP1) or 2 (SP2) guns. Solvent resistant paint. Valid for PPS type adapters. Maximum robustness. High fixing power thanks to its two powerful magnets.

Version	Code
SP 1	40000245
SP 2	40000246



Cleaning kit

Complete cleaning set, including one brush for outside cleaning, and rods of different sizes for all the inner paths of the spray gun. Supplied in a practical show case.

Code
40000086



Lubricant grease

Natural grease, specially made for spray guns and painting equipments moving parts lubrication. High consistency, even under extreme temperatures. Long lasting, it doesn't lose properties over the time.

Code
56418589



Ford 4 Viscosimeter

Immersion cup, made of polyamide (resistant to solvents) with metallic outlet hole (brass).

Code
56418001

Spraygun Accessories

GRAVITY AND SUCTION DEPOSITS

Description	Sprayguns	Code
650 ml. Gravity cup	CLASSIC PRO XD	56418084
650 ml. Gravity cup (sin filtro de producto)	CLASSIC PRO XD	56418085
1,000 ml. Gravity cup (metálico)	CLASSIC PRO XD	56418082
650 ml. Gravity cup	CLASSIC LUX	56418420
600 ml. Gravity cup	JUNIOR G	49000430
125 ml. Gravity cup	474	56418431
1,000 ml. Suction deposit	3300 GTO CLASSIC PRO XD CLASSIC LUX	56418074
5,000 ml. Gravity cup with removable lid and handle	CLASSIC PRO XD SMOOTH PREMIUM 429 N	56418078
5,000 ml. Gravity cup with handle	PREMIUM 429 N	56418077

PRODUCT FILTERS AND SEALING JOINTS

Description	Spraygun model	Code
Gravity deposit product filter 650 ml. (10 units)	CLASSIC PRO XD / LUX	56418017
Suction deposit product filter 1,000 ml. (10 units)	CLASSIC PRO XD	56418014
Air joint replacement kit	CLASSIC PRO XD	56418494
Suction deposit anti-drip lid 1,000 ml. (5 units)	CLASSIC PRO XD / LUX	56418013
Suction deposit closure washer (5 units)	CLASSIC PRO XD / LUX	56418509

ADAPTATION COUPLINGS FOR DISPOSABLE PPS CUPS

Description	Spraygun model	Code
3M PPS Adaptation coupling	CLASSIC PRO XD	55711612
3M PPS 2.0 Adaptation coupling		55711627
MIPA / CARWOX Adaptation coupling		55711616
GERSON / NORTON Adaptation coupling		55711614
FLEXI CUP Adaptation coupling		55711615
DEVILBISS / DEKUPS Adaptation coupling		55711618
SATA RPS Adaptation coupling		55711620
COLAD Adaptation coupling		55711623

AIR VALVES AND PACKING GLANDS

Description	Spraygun model	Code
Air valve Kit (Soft Flow)	3300 GTO	56418669
Air valve Kit	3300 GTO	56418664
Air valve Kit	CLASSIC PRO XD	56418481
Air valve Kit	CLASSIC LUX	56418715
Air valve Kit	JUNIOR G	49000422
Paint Packing nut	3300 GTO	57212211
Paint Packing nut	CLASSIC PRO XD / LUX	56411619
Paint Packing nut	JUNIOR G	49000424



Aircaps / Nozzle and needle kits

The **aircap model** is vital to achieve the desired results. The type of product we are going to apply and the application system we are going to use must both be taken into account when selecting an aircap. We will obtain the desired spray by correctly combining the aircap with the correct nozzle and needle kit, and a proper air supply.

Aircaps

AIRCAP	Spraygun model	Painting system	Recommended application	Nozzle (mm.)	Air consumption	Code
GTO EPA	3300 GTO	EPA	Finishes and primers	1.0 - 1.8	250 L/min. 8.8 cfm	56418645
GTO EVO		EPA	High quality finishes. High gloss, matt colors	1.0 - 1.6	255 L/min. 9.01 cfm	56418558
GTO HVLP		HVLP	Primers. Minimum mist and max. savings. 0.68 bar (10 psi) at nozzle	1.0 - 2.0	360 L/min. 12.71 cfm	56418552
GTO 64 S		EPA	Varnishes and water-based enamels. Forge effect. High microns. Glues and adhesives.	2.2 - 2.5	310 L/min. 10.95 cfm	56418646
GTO 62 S		EPA	High viscosity. Gun polyester, forged effect, ceramic enamels	2.8	270 L/min. 9.53 cfm	56418647
CLASSIC 21 EPA	CLASSIC PRO XD	EPA	Primers. Big fan	1.4 - 1.8	225 L/min. 7.95 cfm	56418639
CLASSIC HVLP		HVLP	Primers and fillers. Min. mist and max. savings 0.68 bar (10 psi) at nozzle	1.4 - 1.8	355 L/min. 11.54 cfm	56418643
25	CLASSIC PRO XD	Medium Pressure	Primers. High thickness	2.0	155 L/min. 5.47 cfm	56418640
36		Medium Pressure	Intermediate layers. High thickness	2.5	205 L/min. 7.24 cfm	56418642
28		Medium Pressure	High viscosity. Gun putties. Forged effect	2.8	240 L/min. 8.48 cfm	56418641

Nozzle and needle kits

Spraygun	Code	Description
3300 range 3300 GTO Classic Pro Suction	10011187	1.00 Nozzle and needle kit
	10011180	1.20 Nozzle and needle kit
	10011191	1.30 Nozzle and needle kit
	10011181	1.40 Nozzle and needle kit
	10011182	1.60 Nozzle and needle kit
	10011183	1.80 Nozzle and needle kit
	10011188	2.00 Nozzle and needle kit
	10011192	2.20 Nozzle and needle kit
	10011189	2.50 Nozzle and needle kit
Classic range Classic Pro XD Gravity	10011190	2.80 Nozzle and needle kit
	10011254	1.40 Nozzle and needle kit
	10011255	1.60 Nozzle and needle kit
	10011256	1.80 Nozzle and needle kit
	10011257	2.00 Nozzle and needle kit
	10011258	2.20 Nozzle and needle kit
	10011259	2.50 Nozzle and needle kit
10011260	2.80 Nozzle and needle kit	

Spraygun	Code	Description
Lux range Classic Lux Gravity	10011380	1.40 Nozzle and needle kit + 40 aircap
	10011370	1.60 Nozzle and needle kit + 40 aircap
	10011371	1.80 Nozzle and needle kit + 40 aircap
Classic Lux Suction	10011372	2.00 Nozzle and needle kit + 41 aircap
	10011373	2.50 Nozzle and needle kit + 42 aircap
474	10011374	1.60 Nozzle and needle kit + 38 aircap
	10011375	1.80 Nozzle and needle kit + 39 aircap
Junior G	10011376	0.80 Nozzle and needle kit
	10011377	1.00 Nozzle and needle kit
	49000431	1.40 Nozzle and needle kit
	49000432	1.60 Nozzle and needle kit
49000433	1.80 Nozzle and needle kit	

Plus range filters

Sagola professional range in regulators, air purifiers, and air lubricators. Plus range has been exclusively designed and manufactured for professional use, it gathers high standard in performance and design.

Solid and mecanized aluminium body

We do not use cast parts. Sturdy elements. High durability. Over air paths size offering higher flow and minimum pressure drop.

Anodising treatment against oxidation

Painting to protect elements is avoided. This gives us endless life. Very high resistance to oxidation or other chemical attack.

Easy reading pressure gauge

Double scale bar/psi gauge.

Semi-automatic draining systems

No manual draining.

Regulation handle

Oversized. Easy manipulations, even with gloves.

Polycarbonate vessel

High-resistant and high transparency. Does not yellow over time.

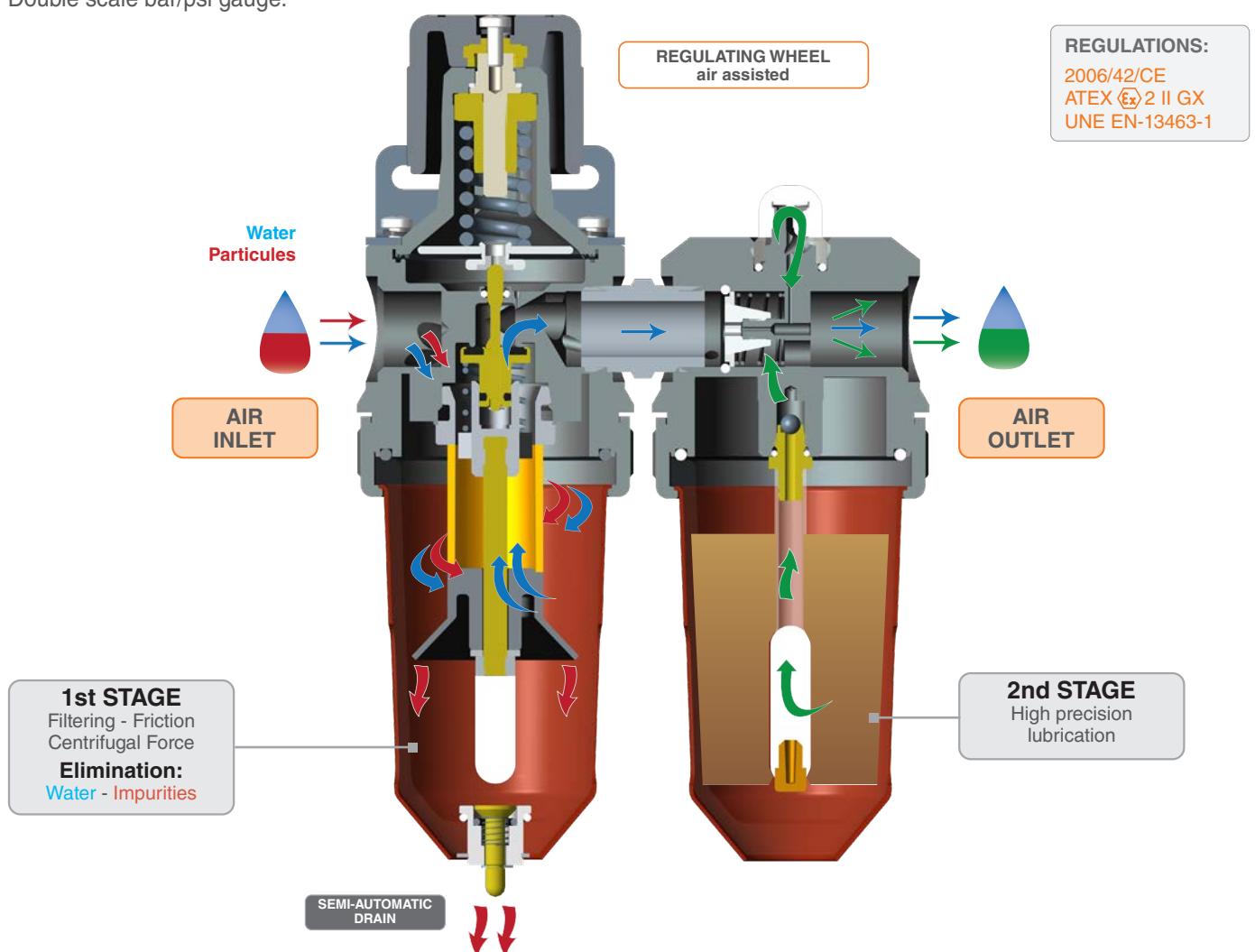

The Plus filter range lubrication system offers maximum smoothness of operation, maximum precision. Easy release, automatic pressure drop.

Air assisted regulator and continuous air supply.

Aluminium body. CNC mechanized. Sturdy build. Liquid and impurities holding.

Plus range filters



479 Plus Filter

The most compact solution for the small workshops, industry or priming and preparation areas.

Large air flow, maximum reliability regulating system, high quality pressure gauge, the best materials. Don't undervalue your small painting works or reduce the life of your pneumatic tools by using poor quality regulators and no filtration capacity.

Adaptable to any size of hose. It comes with reducers. Produced from a solid aluminium block, great filtering capacity with check window for waste particle and semi-automatic drain system, it has everything in a minimum space.



970 Plus Filter

The virtues of the regulator-filter 479+ is now linked to a lubricating element, setting itself apart as specific workshop equipment. It supplies clean, lubricated air to all your pneumatic tools.

Accurate control of the oil content by means of a "drop-by-drop" hand regulator, zero pressure loss thanks to the in-line design, maximum reliability and productivity in the most compact package.

Assure the supply of clean air and properly lubricated to tools and pneumatic engines.

TECHNICAL DATA

	479 PLUS		970 PLUS	
Weight	0.72 Kg.	1.58 lbs	1.24 Kg.	2.72 lbs
Dimensions	22.5 x 6.5 x 8.5 cm	8.86 x 2.56 x 3.35"	22.5 x 14 x 8.5 cm	8.86 x 5.5 x 3.35"
Air flow at 2 bar (29 psi)	1,700 L/min.	60 cfm	1,920 L/min.	68 cfm
Connections	1/2", 3/8", 1/4"		1/2", 3/8", 1/4"	
Filtering type	1st 40 µ bronze filter		1st 40 µ bronze filter	
Maximum working pressure	10 bar	145 psi	10 bar	145 psi
Maximum working temperature	90°C	194°F	90°C	194°F
Drain system	Automatic drain		Semi-automatic drain	

VERSIONS

Description	Code
479 Plus air regulator filter with 1/2" connection	10730401
479 Plus air regulator filter with 3/8" connection	10730402
479 Plus air regulator filter with 1/4" connection	10730403
970 Plus air lubricator regulator filter with 1/2" connection	10750301
970 Plus air lubricator regulator filter with 3/8" connection	10750302
970 Plus air lubricator regulator filter with 1/4" connection	10750303

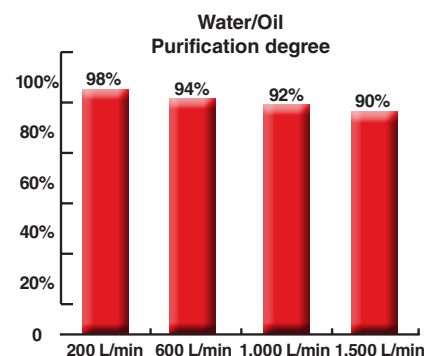

Plus range filters



430 Plus regulator

Mini air regulator. Small, robust, reliable and long lasting. Mechanized from a solid aluminium block.

Diaphragm regulator from 0 to 10 bar. High pressure regulator. Quality pressure gauge up to 10 bar. Double scale bar/psi.

Stand included for assembly on the wall. Standard adaptors and fittings included. Quick release and short shift wheel.

439 Plus Filter

High flow filter for insertion in air lines. Suitable for all type of installations, accessories included. Made of aluminium. High-durability.

Check window for waste liquids. Semi-automatic drain system. Minimum pressure loss.

Minimum maintenance.

437 Plus Lubricator

Ideal for the proper lubrication of pneumatic tools. Multiple inlet and outlet dimensions (1/2", 3/8" and 1/4"). Oil level check window.

Manual oil regulator by level check window, "drop by drop" system. CNC mechanized from a solid aluminium block. Made of aluminium, as the whole Plus range.

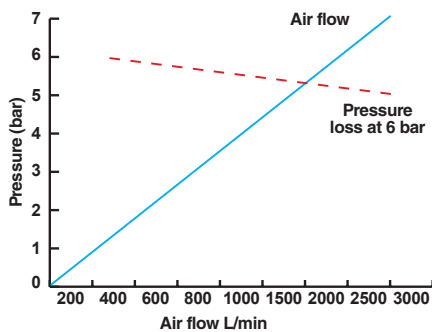

TECHNICAL DATA

	430 PLUS		439 PLUS		437 PLUS	
Weight	0.54 Kg.	1.19 lbs	0.55 Kg.	1.21 lbs	0.48 Kg.	1.06 lbs
Dimensions	10.7 x 6.5 x 11.5 cm 4.21 x 2.56 x 4.53"		15.8 x 7.3 x 7.3 cm 6.22 x 2.87 x 2.87"		16.5 x 7.3 x 7.3 cm 6.50 x 2.87 x 2.87"	
Air flow at 2 bar (29 psi)	1,200 - 1,700 L/min.	42 - 60 cfm	1,280 L/min.	45 cfm	1,920 L/min.	68 cfm
Connections	1/2", 3/8", 1/4"		1/2", 3/8", 1/4"		1/2", 3/8", 1/4"	
Filtering type	-		1st 40 µ bronze filter		-	
Maximum working pressure	10 bar	145 psi	10 bar	145 psi	10 bar	145 psi
Maximum working temperature	90°C	194°F	90°C	194°F	90°C	194°F
Drain system	-		Semi-automatic drain		Semi-automatic drain	

VERSIONS

Description	Code
430 Plus micro air regulator with 1/2" connection	10740501
430 Plus micro air regulator with 3/8" connection	10740502
430 Plus micro air regulator with 1/4" connection	10740503
439 Plus air filter with 1/2" connection	10720401
439 Plus air filter with 3/8" connection	10720402
439 Plus air filter with 1/4" connection	10720403

VERSIONS

Description	Code
437 Plus Lubricator with 1/2" connection	10710301
437 Plus Lubricator with 3/8" connection	10710302
437 Plus Lubricator with 1/4" connection	10710303

FR/FRL/RA range

Regulator filter FR

Air purifying filter with pressure regulator and manometer.

High precision regulation manometer. Polycarbonate vessel with high resistance metal protection with a capacity of 30 cm³.

The filtering system retains water and impurities. Filtered water by centrifugation. 40 micron particle filter. Great air flow.

Semi-automatic purge system.

Lubricator Regulator Filter FRL

Compact model that combines the FR range filter system with a lubricator.

Increases the life and optimizes the performance of pneumatic machinery. The FRL 404 model is recommended for tools and motors with high air consumption as well as for the work of several tools at the same time.

Regulator RA

Valid for all types of machinery.

It incorporates high precision and high quality regulation manometer. Constant airflow and pressure.



REGULATIONS:
2006/42/CE
ATEX 2 II GX
UNE EN-13463-1

TECHNICAL DATA	FR		FRL		RA	
Weight (Mod. 302/303)	480 g.	1.06 lbs	885 g.	1.95 lbs	400 g.	0.88 lbs
Weight (Mod. 404)	1,040 g.	2.3 lbs	1,740 g.	3.84 lbs	820 g.	1.81 lbs
Dimensions (Mod. 302/303)	53 x 211 mm.		117 x 211 mm.		53 x 128 mm.	
Dimensions (Mod. 404)	70 x 262 mm.		154 x 262 mm.		70 x 150 mm.	
Air flow (Mod. 302/303)	1,500 L/min.	53 cfm	1,500 L/min.	53 cfm	-	
Air flow (Mod. 404)	2,100 L/min.	74 cfm	2,100 L/min.	74 cfm	-	
Filtering type	40 µ filtering		40 µ filtering		-	
Working pressure range	0 - 12 bar	0 - 174 psi	0 - 12 bar	0 - 174 psi	0 - 12 bar	0 - 174 psi
Working temperature	-10 to 60°C	194°F	-10 to 60°C	194°F	-10 to 60°C	194°F
Drain system	Semi-automatic drain		Semi-automatic drain		-	

VERSIONS	1/2" Connection		3/8" Connection		1/4" Connection	
Description	Code		Code		Code	
FR range Air regulator filter	FR 404	40000181	FR 303	40000180	FR 302	40000179
FRL range Lubricator regulator filter	FRL 404	40000224	FRL 303	40000223	FRL 302	40000222
RA range Air regulator	RA 404	40000187	RA 303	40000186	RA 302	40000185

Air hoses

Anti-static air hose

Anti-static compressed air hose ideal for painting in the booth. Light, flexible and manageable. Twist free.

EPDM rubber hose with exterior textile reinforcement

High security crimped ends able to bear the high temperatures of the booth. No need to use flanges, avoiding that they release or cause leaks due to dilation.

8 mm. inner diameter. Valid to work with high flow HVLP sprayguns.

1/4" F couplings with conical closure and flare fitting for easy assembly of the push connector.



REGULATIONS:
97/23/CE
UNE EN-559

TECHNICAL DATA

TECHNICAL DATA		ANTI-STATIC AIR HOSE	
Temperature range	-40°C to 120°C	-40°F to 248°F	
Maximum working pressure	20 bar	290 psi	
Breakage pressure	80 bar	1.160 psi	
Material (inside)	EPDM (Ethylene Propylene Diene type M ASTM)		
Material (outside)	Textile reinforcement	Colour	Blue
Connections	BSP 1/4" F couplings with conical closure and flare fitting		
Conducting pipe	< 1 M Ω		

VERSIONS

Description	Code	Code	Code
2.5 m. Anti-static air hose Ø 6 x 12 mm.	56414014	-	-
6 m. Anti-static air hose Ø 8 x 15 mm.	56414024	-	-
11 m. Anti-static air hose Ø 8 x 15 mm.	56414025	56414047	56414049
16 m. Anti-static air hose Ø 8 x 15 mm.	56414027	56414048	56414050
26 m. Anti-static air hose Ø 8 x 15 mm.	56414026	-	-



Air hose

Multi-use hose. Compact with excellent performance and oil resistance. 8 x 15 mm. hose in different lengths and in rolls of 100 meters. Made of Thermorubber with external Polyester reinforcement. 8 mm. inner diameter. Valid to work with high flow HVLP sprayguns.

Working pressure: 20 bar (60 bar of breakage pressure).

Temperature range: de -15°C to 60°C

REGULATIONS:
97/23/CE

VERSIONS

Description	Code	Code	Code
100 m. Air hose roll Ø 8 x 15 mm.	52450008	-	-
11 m. Air hose Ø 8 x 15 mm.	-	56414051	56414053
16 m. Air hose Ø 8 x 15 mm.	-	56414052	56414054



Air hose with connections available in 11 and 16 m.

Quick couplings

Couplings and Connectors

The new range of plugs SAGOLA presents cutting-edge design. SAGOLA offers a wide range that gives cover 100% of market requirements. Is incorporated security versions. All steel and aluminum plugs are BSP; Males (BSPT) and females (BSPP).

Plug body made of treated steel and valve made of brass. So a guaranteed life of more than 1,500,000 uses. The new range of plugs SAGOLA incorporates a handle made of composite, which gives a high resistance to both attrition and drag. Attrition resistance tested in more than 48,000 impacts and the equivalent to a crawl 12 km.

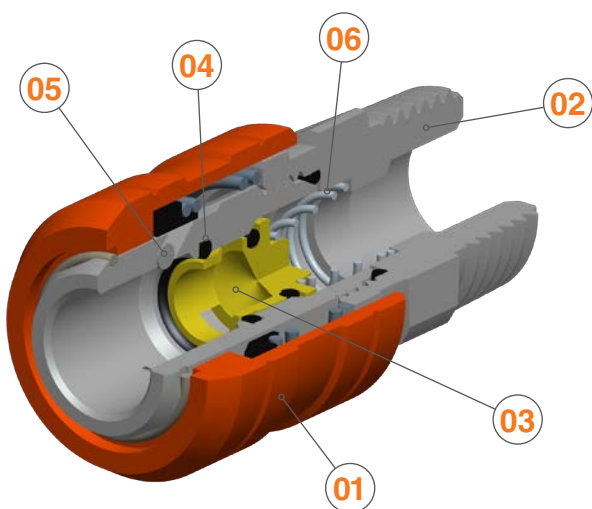

1. **SHOOTER** made of composite with a weight reduction and extraordinary durability against impact.
2. **BODY PLUG** made of steel with anticorrosive treatment.
3. **VALVES** Brass valve manufactured, specific to work at high temperatures.
4. **JOINTS** Nitrile Butadiene. Operating temperature range: -20°C +100°C.
5. **PINS** made of tempered high strength steel that guarantees the absence of attrition.
6. **SPRING** made of stainless steel.

US-Mil range

ULTRA LIGHT (45 grams)

Quick coupling

US-Mil RANGE

Flow: 68 m³/h. - 1,133 L/min.
Body and shooter made of high strength **aluminum**. Valve made of brass. Pins made of high strength steel.
Air coupling: 1/4"



Code	Version
11010531	BSPT 1/4"



Code	Version
11010431	BSPP 1/4"



Code	Version
11010629	Barb. 8 mm.

US-Mil range

STANDARD

Quick coupling

US-Mil RANGE

Flow: 68 m³/h. - 1,133 L/min.
Simple shutter plug, made of hardened **steel** with gasket made of Nitrile Butadiene. Its excellent sealing prevent dirt penetrates inside. High strength sleeve.



Code	Version
11010524	BSPT 1/4"

11010525	BSPT 3/8"
----------	-----------

11010526	BSPT 1/2"
----------	-----------



Code	Version
11010424	BSPP 1/4"

11010425	BSPP 3/8"
----------	-----------

11010426	BSPP 1/2"
----------	-----------



Code	Version
11010624	Barb. 8 mm.

11010625	Barb. 10 mm.
----------	--------------

25 UNITS

11010527	BSPT 1/4"
----------	-----------

11010427	BSPP 1/4"
----------	-----------

11010626	Barb. 8 mm.
----------	-------------

US-Mil range

SAFETY

Quick coupling

US-Mil RANGE

Flow: 68 m³/h. - 1,133 L/min.
Plug made of hardened **steel** with gasket made of Nitrile Butadiene and double effect opening. Anti-whiplash safety plug according to ISO-4414. Two movements "push-pull" to disconnect.
High strength sleeve.



Code	Version
11010528	BSPT 1/4"

11010529	BSPT 3/8"
----------	-----------

11010530	BSPT 1/2"
----------	-----------



Code	Version
11010428	BSPP 1/4"

11010429	BSPP 3/8"
----------	-----------

11010430	BSPP 1/2"
----------	-----------



Code	Version
11010627	Barb. 8 mm.

11010628	Barb. 10 mm.
----------	--------------

Quick couplings

Euro-Profile range

STANDARD

Quick coupling

Euro Profile RANGE

Flow: 85 m³/h. - 2,000 L/min.
Simple shutter plug, made of hardened **steel** with gasket made of Nitrile Butadiene. Its excellent sealing prevent dirt penetrates inside. High strength sleeve.
Air coupling: 7.6 mm.



Code	Version
11010823	BSPT 1/4"
11010824	BSPT 3/8"
11010825	BSPT 1/2"



Code	Version
11010723	BSPP 1/4"
11010724	BSPP 3/8"
11010725	BSPP 1/2"



Code	Version
11010924	Barb. 8 mm.
11010923	Barb. 10 mm.

Euro-Profile range

 **SAFETY**

Quick coupling

Euro Profile RANGE

Flow: 85 m³/h. - 2,000 L/min.
Plug made of hardened **steel** with gasket made of Nitrile Butadiene and double effect opening. Anti-whiplash safety plug according to ISO-4414. Two movements "push-pull" to disconnect.
High strength sleeve.
Air coupling: 7.6 mm.



Code	Version
11011323	BSPT 1/4"
11011324	BSPT 3/8"
11011325	BSPT 1/2"



Code	Version
11011423	BSPP 1/4"
11011424	BSPP 3/8"
11011425	BSPP 1/2"



Code	Version
11011523	Barb. 8 mm.
11011524	Barb. 10 mm.

Multi-Profile range

3x1 system. Compatibility: US-MIL/EUROPROFILE/ITALIAN PROFILE **STANDARD**

Quick coupling

Multi Profile RANGE

Flow: 85 m³/h. - 2,000 L/min.
Simple shutter plug, made of **steel** with gasket made of Nitrile Butadiene. Its excellent sealing prevent dirt penetrates inside.
Air coupling: 8 mm.



Code	Version
11010826	BSPT 1/4"
11010827	BSPT 3/8"



Code	Version
11010726	BSPP 1/4"
11010727	BSPP 3/8"



Code	Version
11010925	Barb. 8 mm.
11010926	Barb. 10 mm.

Nitto range

ASIA-PACIFIC market exclusive profile **STANDARD**

Quick coupling

Nitto RANGE

Flow: 85 m³/h. - 2,000 L/min.
Simple shutter plug, made of **steel** with gasket made of Nitrile Butadiene. Its excellent sealing prevent dirt penetrates inside.
Air coupling: 8 mm.



Code	Version
11011701	BSPT 1/4"
11011702	BSPT 3/8"



Code	Version
11011801	BSPP 1/4"
11011802	BSPP 3/8"



Code	Version
11011901	Barb. 8 mm.
11011902	Barb. 10 mm.

US-Mil range

Brass plug **STANDARD**

Quick coupling

US-Mil RANGE

Spec C-4109
Flow: 600 L/min.
Versatile. Simple blocking plug made of **brass** with Buna N gasket. Its excellent sealing avoids the penetration of impurities to the inside. Fully compatible with earlier lines of SAGOLA plugs.



Code	Version
11010520	BSPT 1/4"
11010521	BSPT 3/8"
11010522	BSPT 1/2"



Code	Version
11010420	BSPP 1/4"
11010421	BSPP 3/8"
11010422	BSPP 1/2"



Code	Version
11010621	Barb. 8 mm.
11010622	Barb. 10 mm.

25 UNITS

11010523	BSPT 1/4"
----------	-----------

11010423	BSPP 1/4"
----------	-----------

11010623	Barb. 8 mm.
----------	-------------

Quick couplings

The size 2 plug is the most commonly used push plug in paint and body shops, and also in industry for the connection of all kinds of pneumatic tools. Silicone free. All springs, valves

and pins made of stainless steel. All SAGOLA connectors are manufactured in high carbon steel making them extremely strong and stress resistant.

US-Mil range

Connector without blocker. Made of steel.

Quick connector US-Mil RANGE Spec C-4109 (2 units) Air coupling: 5,5 mm. Fully compatible with earlier lines of SAGOLA plugs. Made of high-carbon steel . Anti-corrosive nickel etched finish. Connector without blocker.		Code	Version		Code	Version		Code	Version
		11020420	BSPT 1/4"		11020520	BSPP 1/4"		11020621	Barb. 8 mm.
		11020421	BSPT 3/8"		11020521	BSPP 3/8"		11020622	Barb. 10 mm.
		11020422	BSPT 1/2"		11020522	BSPP 1/2"			
50 UNITS		11020423	BSPT 1/4"		11020524	BSPP 1/4"		11020623	Barb. 8 mm.

US-Mil range

Orientable connector.

Orientable Quick connector US-Mil RANGE (2 units)
 Air coupling: 5,5 mm.
 Exclusive rotating dial system, for greater freedom of movement. Made of high-carbon **steel**. Anti-corrosive nickel etched finish. Connector without blocker.



Code	Version
11020523	BSPP 1/4"



Code
70000011

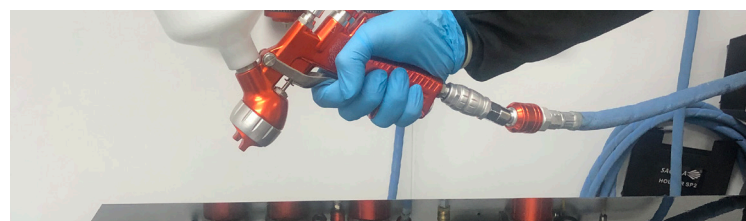

Plugs display box

Sagola plugs and connectors range sampler.



Euro-Profile range

Maximum performance and durability in high production workshops

Quick connector Euro-Profile RANGE (2 units) High flow. Air coupling: 7-8 mm. Made of high-carbon steel . Anti-corrosion blue galvanized finish. Connector without blocker.		Code	Version		Code	Version		Code	Version
		11020710	BSPT 1/4"		11020810	BSPP 1/4"		11020921	Barb. 8 mm.
		11020721	BSPT 3/8"		11020821	BSPP 3/8"		11020922	Barb. 10 mm.
		11020722	BSPT 1/2"		11020822	BSPP 1/2"			

Nitto range

ASIA-PACIFIC market exclusive profile

Quick connector Nitto RANGE (2 units) High flow. Air coupling: 7-8 mm. Made of high-carbon steel . Anti-corrosion treatment. Connector without blocker.		Code	Version		Code	Version		Code	Version
		11021001	BSPT 1/4"		11021101	BSPP 1/4"		11021201	Barb. 8 mm.
		11021002	BSPT 3/8"		11021102	BSPP 3/8"		11021202	Barb. 10 mm.

Threaded couplings



Connection coupling

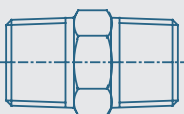
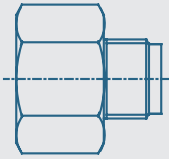

High flow. Made of brass with anti-corrosive treatment. (2 units)

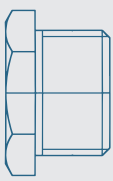
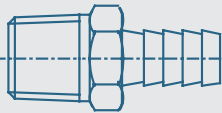
	Code	Version		Code	Version
	11000101	BSPT 1/4" M-M		11000104	BSPT 1/2" M - 3/8" M
	11000102	BSPT 1/2" M-M		11000105	BSPT 3/8" M - 1/4" M
	11000103	BSPT 3/8" M-M		11000112	BSPT 1/2" M - 3/8" F
			11000113	BSPT 1/2" M - 1/4" F	

	Code	Version		Code	Version
	11000106	BSPP 1/2" H - 3/8" M		11000109	BSPT 1/2" M - Barb. 8 mm.
	11000107	BSPP 3/8" H - 1/4" M		11000110	BSPT 3/8" M - Barb. 8 mm.
	11000108	BSPP 3/8" M - 1/4" F		1100011	BSPT 1/4" M - Barb. 8 mm.





How to connect and disconnect the plug?

Standard plug connect and disconnect

1. Press until coupled
2. Pull the body as the arrow indicates
3. Disconnect the plug

Safety plug connect and disconnect

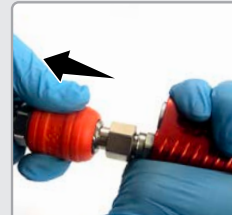
1. Move plug and tool as indicated by arrows
2. Push the plug
3. Pull the plug
4. Disconnect the plug



The **XTech line of Airbrushes** has been developed and manufactured under the strictest quality requirements in order to offer a reliable product with a high technical level.

High performance airbrushes. The preferred choice of airbrushing professionals. Airbrushes for automotive, fine arts, bodypaint, tanning, illustration, make-up, model making, confectionery, temporary tattoo - tattoo, textiles, nail decoration...

XTech 500 Airbrush

Sagola XTech 500 airbrush. Dual action professional airbrush and suction feed paint system.

0.3 and 0.5 mm. needle and nozzles, that offer a fine spraying from a high precision to a large spray pattern.

22 ml. suction deposit with fast change system. Ideal for changing color in an instant.

Ideal for projects such as T-shirts, Remote control cars,... In general, larger jobs.

- Needle closing and packing made of Teflon.
- Highly precise and smooth air and product valve.
- Working pressure 15/30 psi 1/2 bar
- Air inlet connection: 1/8" male



Version	Code
Ø 0.3 XTech 500	17410901
Ø 0.5 XTech 500	17410902

XTech 300 Airbrush

Sagola XTech 300 airbrush. Dual action professional airbrush and gravity feed paint system.

0.3 mm. needle and nozzle set up, that offers a fine pulverization and a good precision.

5 ml. deposit to use any paint quantity, but maintaining the advantage of an easy cleaning and colour change.



Version	Code
Ø 0.3 XTech 300	17410701

Junior 140 Beginner Airbrush

Double effect initiation airbrush for the world of blending and bodywork design.

It is served with complete accessory equipment. Includes air hose and compressor adapter.



Version	Code
Ø 0.8 Junior 140	25410104

Junior Start Beginner Airbrush

Basic single effect initiation airbrush and external mix. Includes air hose and compressor adapter.



Code
4000240

Petroleadora Classic P1 / Adhesivos

Classic P1 Oil Gun

Oil gun for cleaning machinery and engines with a 1 liter capacity tank.

Product flow easily regulated by means of the sprayer. Round projection of the product to achieve excellent cleaning.

Ergonomic gun design. Easy to use, hang, comfortable and perfect for both left-handed and right-handed users. Strong aluminum body suitable for industrial environments. Minimum maintenance.

For application sectors such as bodywork and industrial machinery.

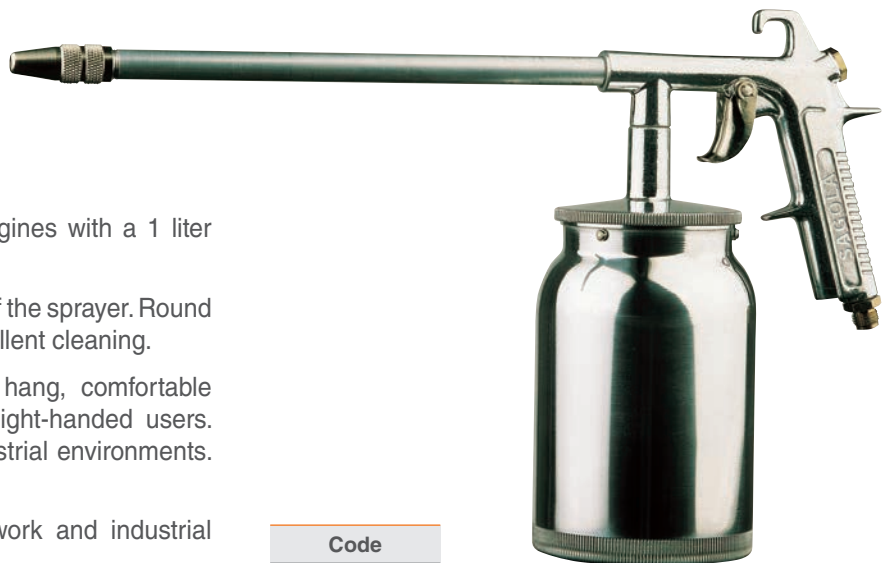

Code
20340701

TECHNICAL DATA

CLASSIC P1

Dimensions	40.2 x 10.2 x 25.5 cm.	15.8 x 4 x 10"
Weight (empty)	734 g.	1.62 lbs
Deposit capacity	1 liter	0.22 Galon US
Air consumption at 6 bar (87 psi)	146 L/min.	5.16 cfm
Work pressure	3 - 10 bar	43.5 - 145 psi
Maximum air inlet pressure	10 bar	145 psi
Connections	BSP 1/4" M	

Sagola Adhesives gun

Especially for bead applications of glues and adhesives. White glue application for the wood industry.

Teflon-coated body makes cleaning easy.

Incorporates a series of 1 and 2 mm. caps and product flow regulator.

The 3 mm. aircap, scoring aircap (to mark lines) and 4-aperture aircap (to apply glue to cavities) can be acquired as options.



VERSIONS / ACCESSORIES

Description		Code
Sagola Adhesives gun		10151401
Nozzle for glues Ø 1 mm.	Included	56418030
Nozzle for glues Ø 2 mm.	Included	56418026
Nozzle for glues Ø 3 mm.	Accessory	56418027
Nozzle for glues (slotted)	Accessory	56418029
Nozzle for glues (4 holes)	Accessory	56418028

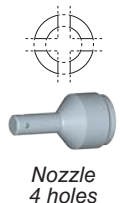

3900 Plus sealant guns



3900 Plus M6



3900 Plus M4



3900 Plus

3900 Plus sealant guns

The SAGOLA 3900 Plus pneumatic sealers are a compact, efficient and light solution for everyday needs in any workshop. These pneumatic guns are very useful when it comes to structure assembling, repairs and windshield set-ups, amongst others.

There are two versions: the 3900 Plus for sealants in cartridges and the 3900 Plus M4/6 for sealants in sausages. Both versions include a trigger with discharge valve, which guarantees a great precision and control.

The metallic internal parts assure a long working life. Besides, those parts do not require any manipulation neither any maintenance.

Its body is made of high resistance aluminum. The front part on the 3900 Plus is made of non-deformable plastic.

Very strong product capable to work for long working hours.

TECHNICAL DATA

3900 PLUS

	3900 Plus		3900 Plus M4		3900 Plus M6	
Length	250 mm.	9.84"	250 mm.	9.84"	320 mm.	12.60"
Weight	650 g.	1.43 lbs	780 g.	1.72 lbs	965 g.	2.13 lbs
Air inlet connection	BSP 1/4" M		BSP 1/4" M		BSP 1/4" M	
Standard supply type	Cartridge		Sausages		Sausages	
Capacity	300 ml.	10.14 oz fl	300/400 ml.	10.1/13.5 oz fl	300/400/600 ml.	10.1/13.5/20.29 oz fl
Working pressure	4 - 6 bar	58 - 87 psi	4 - 6 bar	58 - 87 psi	4 - 6 bar	58 - 87 psi
Maximum air inlet pressure	10 bar	145 psi	10 bar	145 psi	10 bar	145 psi
Material on the front	Plastic		Anodized aluminum		Anodized aluminum	
Discharge valve	OK		OK		OK	

3900 Plus sealant guns

Sealant Gun main parts

- 01** AIR VALVE
- 02** AIR INLET
- 03** TRIGGER
- 04** ALUMINIUM BODY
- 05** ALUMINUM FRONT
- 06** PLASTIC FRONT
- 07** PISTON

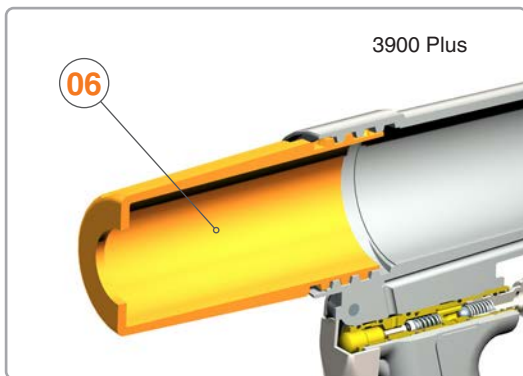
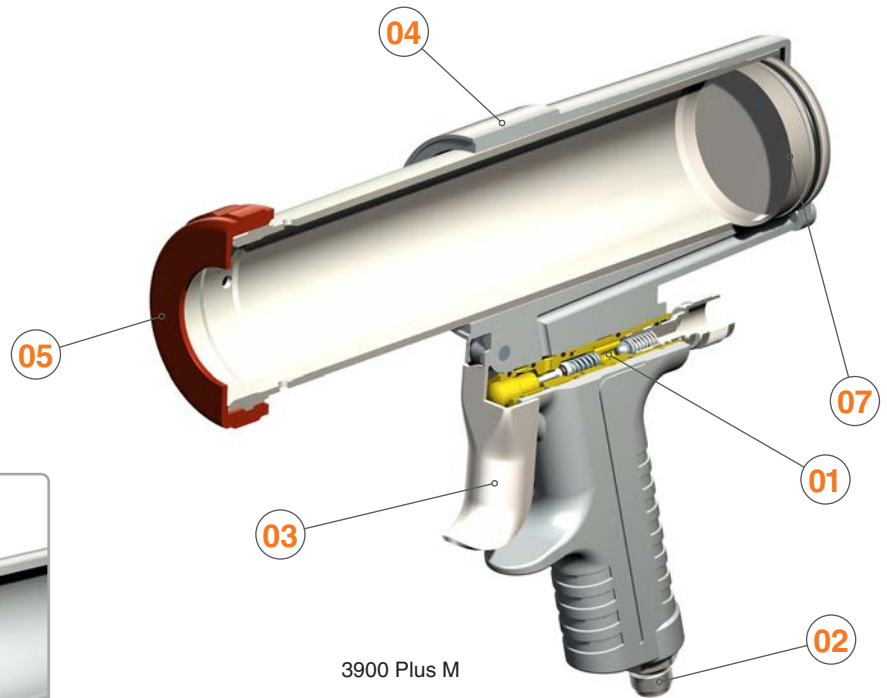

VERSIONS

Description	Code
3900 Plus sealant gun	10330201
3900 Plus M4 sealant gun	10330401
3900 Plus M6 sealant gun	10330402

Preparation of the cartridge or sausage

Cartridge preparation 3900 Plus

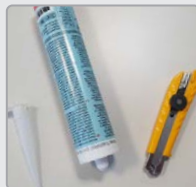

1. Cut the end of the cartridge and cap



2. Attach the cap to the cartridge



3. Remove the front cover and insert the cartridge



4. Close the deposit with the front cover

Sausage preparation 3900 Plus M



1. Cut off the end of the sausage



2. Remove the front cover of the deposit



3. Insert the cap



4. Place the sausage inside the deposit



5. Close the deposit with the front cover

416 anti-gravel gun

416 anti-gravel gun

Pneumatic gun for antigravel cartridges and underbody protection. Operation by suction.

Gun for the application of standardized acoustic insulation 1 L. cartridges. To be screwed directly to the cartridge.

Adjustable metallic aircap to control the quantity and texture of the product.



TECHNICAL DATA

416

Dimensions	18.7 x 4.5 x 31.1 cm.	7.4 x 1.8 x 12.2"
Weight (empty)	0.52 Kilograms	1.15 lbs
Air consumption	160 L/min. (at 3.5 bar)	5.65 cfm (at 50.7 psi)
Working pressure	3 - 10 bar	43.5 - 145 psi
Maximum air inlet pressure	10 bar	145 psi
Connections	BSP 1/4" M	

Description	Code
416 anti-gravel gun	20330401



Screwed directly to the cartridge

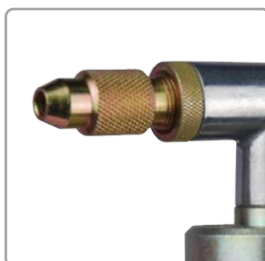

Adjustable metallic aircap



1/4" air inlet

Classic S1 Blowguns

Classic S1 blowguns

Blowgun with body built in aluminum. Light but robust. Air inlet 1/4" male.

Three versions of the blow gun Classic S1:

- Classic S1 with metallic aircap.
- Classic S1 with extension aircap.
- Classic S1 with plastic aircap.



*Classic S1
Metallic*

Code
20340601



*Classic S1
Plastic*

Code
20340603



*Classic S1
Extension*

Code
20340604

Classic S1 Venturi blowgun

Multiply the air flow X4 with the help of the Venturi system offered by this version of the Classic S1. Blowgun with body built in aluminum. Light but robust. Air inlet 1/4" male.



*Classic S1
Venturi*

Code
20340605

Pocket blower

Small size blower. Pen-type clip. Adjustable flow. Quick disconnect connector.



*Pocket
blower*

Code
40000336

TECHNICAL DATA

Classic S1/Venturi/Blower

		Classic S1		Classic S1 Venturi		Pocket blower	
Dimensions	Metallic	11,7 x 2,5 x 15,3 cm.	4,6 x 1 x 6"	15.8 x 2.7 x 15.3 cm.	6.2 x 1.06 x 6"	113 mm. (close) 116 mm. (open)	4.45" (close) 4.57" (open)
	Plastic	11,7 x 2,5 x 15,3 cm.	4,6 x 1 x 6"				
	Extension	20,6 x 2,5 x 15,3 cm.	8,1 x 1 x 6"				
Weight		190 g. / 187 g. / 198 g. 0.418 lbs / 0.413 lbs / 0.436 lbs		225 g.	0,5 lbs	23 g.	0.05 lbs
Air inlet connection		Connection 1/4" M		Connection 1/4" M		1/4" M US-Mil	
Air consumption (at 6 bar)		240 L/min.	8.5 cfm	240 L/min.	8.5 cfm	450 L/min.	15.9 cfm
Air flow ratio (air outlet)		1:1		4:1 (925 L/min. - 33 cfm)		1:1	
Working pressure		3 - 6 bar	43.5 - 87 psi	3 - 6 bar	43.5 - 87 psi	3 - 6 bar	43.5 - 87 psi
Maximum air inlet pressure		10 bar	145 psi	10 bar	145 psi	10 bar	145 psi

Turbo 1000



Turbine Turbo 1000

Autonomous HVLP painting equipment.

The equipment consists of a turbine, a gun and a hose. The gun rests on the turbine in the gun holder. It incorporates a cable collection system. The turbine body includes an accessory holder.

It incorporates two combinations of standard fluid nozzle. The air cap of the gun has four positions to achieve a vertical fan, flat fan or round jet. All of them are adjustable in size.

The generation of painting with hot air allows to work with a low level of dilution in the paints and a faster drying of these.

Painting equipment valid for all types of paints. Finishes, primers, multicolors,...

TECHNICAL DATA

TURBO 1000

Complete equipment Weight	4.8 Kilograms	1.09 lbs
Turbine Dimensions	17 x 10 x 32 cm.	6.7 x 3.9 x 12.6 "
Power	1,000 w	
Deposit	500 ml. capacity (169 fl oz.)	
Hose Length	2.5 m.	98.4 "
Maximum air pressure	0.28 bar	4 psi
Materials in contact with the product	Anodized aluminum, chromed aluminum, POM, INOX and Brass	



Gun
Aluminum deposit

VERSIONS / ACCESSORIES

Description		Code
Turbine TURBO 1000 PRO	220 V / 50 Hz	40000318
Turbine TURBO 1000 PRO	120 V / 60 Hz	40000497
Gun with Aluminum deposit	Accessory	49000312



Classic I Plus / Classic I 2

Classic I Plus Inflator - checker gun

Professional inflator-checking pressure gun. Made of aluminum. High robustness and reliability. With pressure gauge protector against impacts.



Code

10310201



TECHNICAL DATA

		Classic I Plus
Dimensions	23.4 x 9.8 x 13 cm.	9.2 x 3.8 x 5.1"
Weight	800 g.	1.76 lbs
Hose length	0.5 m.	19.7"
Work pressure	2 - 10 bar	29 - 145 psi
Maximum air inlet pressure	10 bar	145 psi
Connections	BSP 1/4" M	

Classic I 2 Inflator - checker gun

Professional inflator-checking pressure gun. Made of aluminum. High robustness and reliability. With pressure gauge protector against impacts.

Code

40000494



TECHNICAL DATA

		Classic I Plus
Dimensions	23,4 x 9,8 x 13 cm.	9,2 x 3,8 x 5,1"
Weight	800 g.	1,76 lbs
Hose length	0,5 m.	19,7"
Work pressure	2 - 10 bar	29 - 145 psi
Maximum air inlet pressure	10 bar	145 psi
Connections	BSP 1/4" M	

MP300 breathing mask

MP300 breathing mask

The MP300 mask and A1 filter set has been designed to provide maximum protection against inhalation of organic products with a boiling point over 65°C, without inconveniencing users in any way, enabling them to carry out their work in complete comfort.

The set adapts perfectly to all kinds of expressions and movements, always providing the highest possible level of protection.

The set is made up of a mask and two filters and covers the user's nose, mouth and chin. It is manufactured using light, highly resistant materials that do not have any harmful effects on users' health and hygiene.

The main body of the mask is made from soft natural rubber.

The mask is fitted with an exhaling valve made up of a valve-holder and a membrane, which makes it easier for exhaled air to escape.

It has a comfortable neck strap and head strap that can be easily adjusted to the right length.



REGULATIONS:

EN 140: 1998, EN 143:2000/A1:2006,
EN 14387:2004/A1:2008
Control agency No. 0082

TECHNICAL DATA

Breathing resistance	Inhalation:	2.00 mbar
Flujo sinusoidal 25 x 2 L/min:	Exhalation:	3.00 mbar
Breathing resistance	At 30 L/min. (1.06 cfm):	0.50 mbar (0.007 psi)
Continuous flow inhalation	At 95 L/min. (3.35 cfm):	1.30 mbar (0.019 psi)
CO ₂ Content (dead space)		1.00 %
Leaks to inside (tightness)		< 5.00 %

MP300 BREATHING MASK

VERSIONS / ACCESSORIES

Description		Code
MP300 Mask		14810301
Filter 10 units	Spare part	56418052



Filter spare parts

Classic MP2 breathing mask

Classic MP2 breathing mask

The Classic MP2 mask and A1 filter set has been designed to provide maximum protection against inhalation of organic products with a boiling point over 65°C, without inconveniencing users in any way, enabling them to carry out their work in complete comfort.

The set adapts perfectly to all kinds of expressions and movements, always providing the highest possible level of protection.

The double air inlet through the two filters allows inhalations of a higher air flow, making breathing easier.

Composed of a mask and two filters, it covers the user's nose, mouth and chin. Manufactured with lightweight and highly resistant materials.

Equipped with an exhalation valve that allows easy expulsion of air when breathing.

Elastic strap for a firm and comfortable fit.



REGULATIONS:

EN 140: 1998, EN 143:2000/A1:2006,
EN 14387:2004/A1:2008
Control agency No. 0082

TECHNICAL DATA

Classic MP2 BREATHING MASK

Breathing resistance	Inhalation:	0.52 mbar
Flujo sinusoidal 25 x 2 L/min:	Exhalation:	1.64 mbar
Breathing resistance	At 30 L/min. (1,06 cfm):	0.11 mbar
Continuous flow inhalation	At 95 L/min. (3,35 cfm):	0.33 mbar
CO ₂ Content (dead space)	0,60 %	
Leaks to inside (tightness)	< 2,00 %	

VERSIONS / ACCESSORIES

Description		Code
Classic MP2 Mask		14810201
Filter 10 units	Spare part	56418052



Filter spare parts

FFP2 mask



REGULATIONS:
 UNE-EN 149:2001 + A1:2009 (FFP2)
 Directive EPI UE 2016/425

M200/M210 mask FFP2 Protection

M200 and M210 self-filtering paper masks with FFP2 level protection. These masks are designed for protection against solid and liquid particles of low and medium toxicity.

Suitable for use against non-ferrous metal dust, metal welding fumes, gases and mists of different materials such as lead, aluminum and manganese.

The mask body contains a flexible metal bar for a perfect fit in the nose area.

Adjustment to the head by double elastic band.

The M210 mask incorporates an exhalation valve to make breathing easier.

VERSIONS

Description	Units/Box	Code
M200 Mask	20	40000263
M210 Mask (with valve)	10	40000264

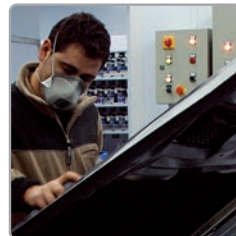

Sanding

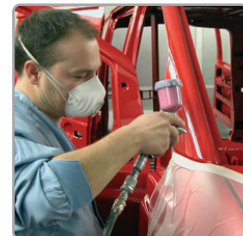

Painting

 **The mask can be used in pollution concentrations up to 10 times the Occupational Exposure Limit (OEL).**

Consumables

Paper paint-strainers

Paper paint-strainers for fast and perfect filtering of the paint.
Paper paint-strainers with 125 or 190 microns Nylon mesh.
To obtain a quick filtering and a surface without speckles.
Supplied in plastic bag to keep them always clean.



VERSIONS

Description	Application	Code
190 µm p. p. strainers	Clearcoats / single stage	40000253
125 µm p. p. strainers	Waterborne paints	40000254

Mixing cups and lids

Cups with legs to prevent spillage. Reinforced top edge.
Made of polypropylene. High resistance.



VERSIONS

Description	Units/Box	Code
400 ml. mixing cup	200	40000508
650 ml. mixing cup	200	40000509
1,300 ml. mixing cup	200	40000510
2,300 ml. mixing cup	175	40000511

VERSIONS

Description	Units/Box	Code
400 ml. cup lid	100	40000512
650 ml. cup lid	100	40000513
1,300 ml. cup lid	100	40000514
2,300 ml. cup lid	100	40000515

Mixing cup dispenser

VERSIONS

Description	Code
400 ml. mixing cup	40000517
650 ml. mixing cup	40000518
1,300 ml. mixing cup	40000519
2,300 ml. mixing cup	40000520



Product mixers

Product mixers of 20 and 30 cm. of length.

VERSIONS

Description	Units/Box	Code
20 x 2 cm. product mixer	500	40000499
30 x 2 cm. product mixer	200	40000320



Particle removal kit

It is used to remove any particles of dust or dirt that may fall on the fresh paint .



Code
40000249

Booth anti-dust. 10 liters

Product for protecting the walls, screens and glass of a spray booth.

- Protects from spray and dust.
- Application with spray gun, roller or brush.
- Transparent and self adhesive layer.
- Clean product.
- Easily removable with water.

Code
40000023





SPAIN

Urartea, 6 · 01010
Vitoria-Gasteiz (Álava) SPAIN
Tel.: (+34) 945 214 150
sagola@sagola.com
www.sagola.com

